

# YAMAHA CX-830/CX-630

*Natural Sound Stereo Control Amplifier*

*Continuously Variable Loudness Control*

*Independent Rec-out Selector*

*8 Audio Inputs, 3 Video Inputs (CX-830)*

*6 Audio Inputs, 2 Video Inputs (CX-630)*

*Programmable Remote Control Transmitter (CX-830 only)*

Thank you for selecting the YAMAHA model CX-830/CX-630 Control Amplifier.



## CONTENTS

Safety Instructions .....	2
Caution .....	3
Supplied Accessories .....	7
Front Panel Descriptions .....	8
Connections .....	10
Operations .....	12
Remote Control Transmitter .....	14
Troubleshooting .....	22
Specifications .....	23

OWNER'S MANUAL



### IMPORTANT!

Please make a note of the serial number of this unit in the space indicated below.

Model: **CX-830/CX-630**

Serial No.:

The serial number is inscribed on the rear of the unit. Keep this Owner's Manual in a safe place for future reference.

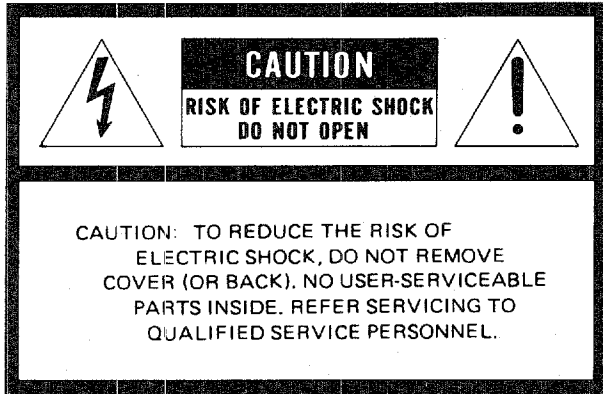

• Explanation of Graphical Symbols

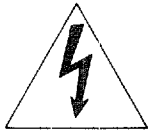

The lightning flash with arrowhead symbol, within an equilateral triangle, is intended to alert you to the presence of uninsulated "dangerous voltage" within the product's enclosure that may be of sufficient magnitude to constitute a risk of electric shock to persons.



The exclamation point within an equilateral triangle is intended to alert you to the presence of important operating and maintenance (servicing) instructions in the literature accompanying the appliance.

**WARNING**

To reduce the risk of fire or electric shock, do not expose this appliance to rain or moisture.

## SAFETY INSTRUCTIONS

**1** Read Instructions – All the safety and operating instructions should be read before the appliance is operated.

**2** Retain Instructions – The safety and operating instructions should be retained for future reference.

**3** Heed Warnings – All warnings on the appliance and in the operating instructions should be adhered to.

**4** Follow Instructions – All operating and other instructions should be followed.

**5** Water and Moisture – The appliance should not be used near water – for example, near a bathtub, washbowl, kitchen sink, laundry tub, in a wet basement, or near a swimming pool, etc.

**6** Carts and Stands – The appliance should be used only with a cart or stand that is recommended by the manufacturer.

**6A** An appliance and cart combination should be moved with care. Quick stops, excessive force, and uneven surfaces may cause the appliance and cart combination to overturn.



**7** Wall or Ceiling Mounting – The appliance should be mounted to a wall or ceiling only as recommended by the manufacturer.

**8** Ventilation – The appliance should be situated so that its location or position does not interfere with its proper ventilation. For example, the appliance should not be situated on a bed, sofa, rug, or similar surface that may block the ventilation openings; or placed in built-in installation, such as a bookcase or cabinet that may impede the flow of air through the ventilation openings.

**9** Heat – The appliance should be situated away from heat sources such as radiators, stoves, or other appliances that produce heat.

**10** Power Sources – The appliance should be connected to a power supply only of the type described in the operating instructions or as marked on the appliance.

**11** Power-Cord Protection – Power-supply cords should be routed so that they are not likely to be walked on or pinched by items placed upon or against them, paying particular attention to cords at plugs, convenience receptacles, and the point where they exit from the appliance.

**12** Cleaning – The appliance should be cleaned or as recommended by the manufacturer.

**13** Nonuse Periods – The power cord of the appliance should be unplugged from the outlet when left unused for a long period of time.

**14** Object and Liquid Entry – Care should be taken so that objects do not fall into and liquids are not spilled into the inside of the appliance.

---

## **CAUTION: READ THIS BEFORE OPERATING YOUR UNIT**

---

**15** Damage Requiring Service – The appliance should be serviced by qualified service personnel when:

- A.** The power-supply cord or the plug has been damaged; or
- B.** Objects have fallen, or liquid has been spilled into the appliance; or
- C.** The appliance has been exposed to rain; or
- D.** The appliance does not appear to operate normally or exhibits a marked change in performance; or
- E.** The appliance has been dropped, or the cabinet damaged.

**16** Servicing – The user should not attempt to service the appliance beyond those means described in the operating instructions. All other servicing should be referred to qualified service personnel.

**17** Power Lines – An outdoor antenna should be located away from power lines.

**18** Grounding or Polarization – The precautions that should be taken so that the grounding or polarization is not defeated.

**1** To ensure the finest performance, please read this manual carefully. Keep it in a safe place for future reference.

**2** Install your unit in a cool, dry, clean place – away from windows, heat sources, and too much vibration, dust, moisture or cold. Avoid sources of hum (transformers, motors). To prevent fire or electrical shock, do not expose to rain and water.

**3** Do not operate the amplifier upside-down. It may overheat, possibly causing damage.

**4** Never open the cabinet. If a foreign object drops into the set, contact your dealer.

**5** Do not use force on switches, knobs or cords. When moving the set, first turn the unit off. Then gently disconnect the power plug and the cords connecting to other equipment. Never pull the cord itself.

**6** Do not attempt to clean the unit with chemical solvents; this might damage the finish. Use a clean, dry cloth.

**7** Always set the volume control to “– ∞ ” while lowering the tonearm to play a record; turn the volume up with the stylus in the groove.

**8** Be sure to read the “Troubleshooting” section on common operating errors before concluding that your unit is faulty.

**9** Do not connect audio equipment to the AC outlets on the rear panel if that equipment requires more power than the outlets are rated to provide.

**1 FRONT PANEL**

**CX-830**

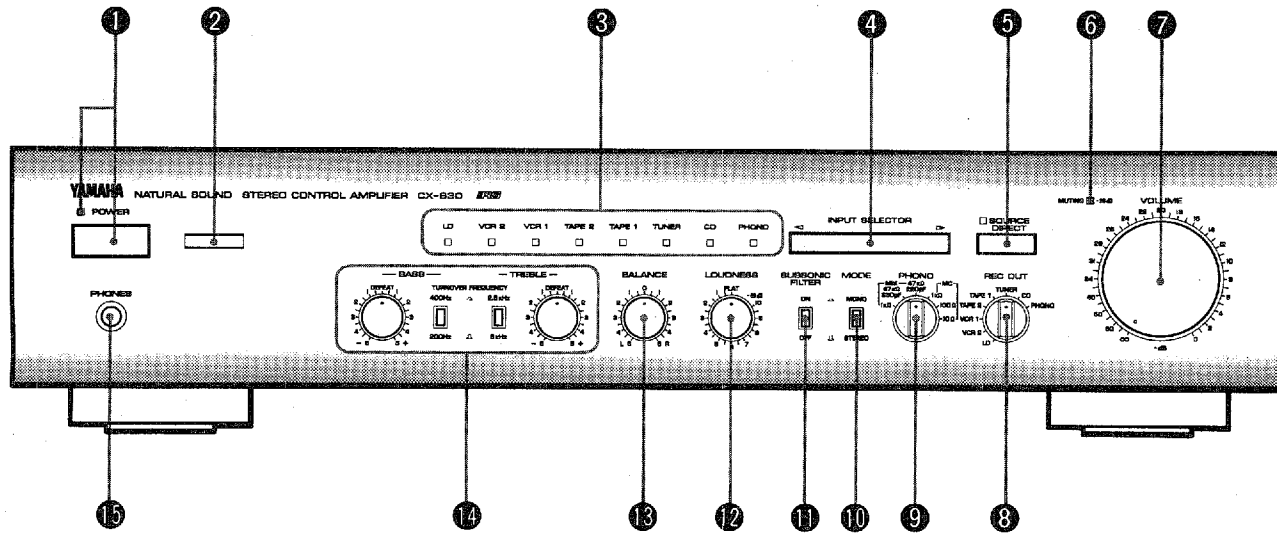

**CX-630**

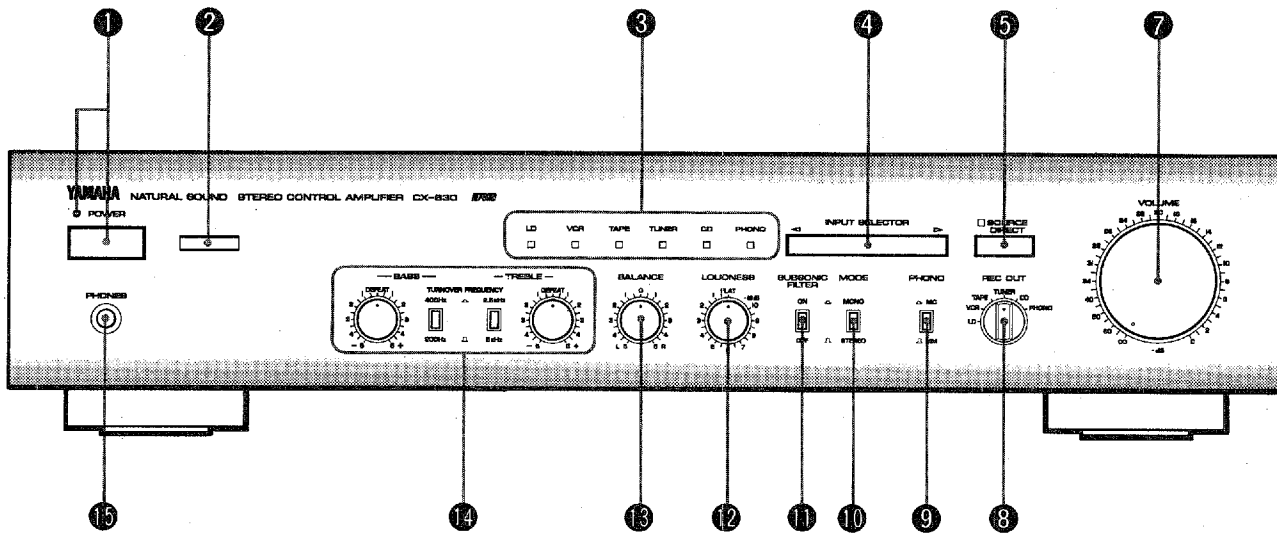

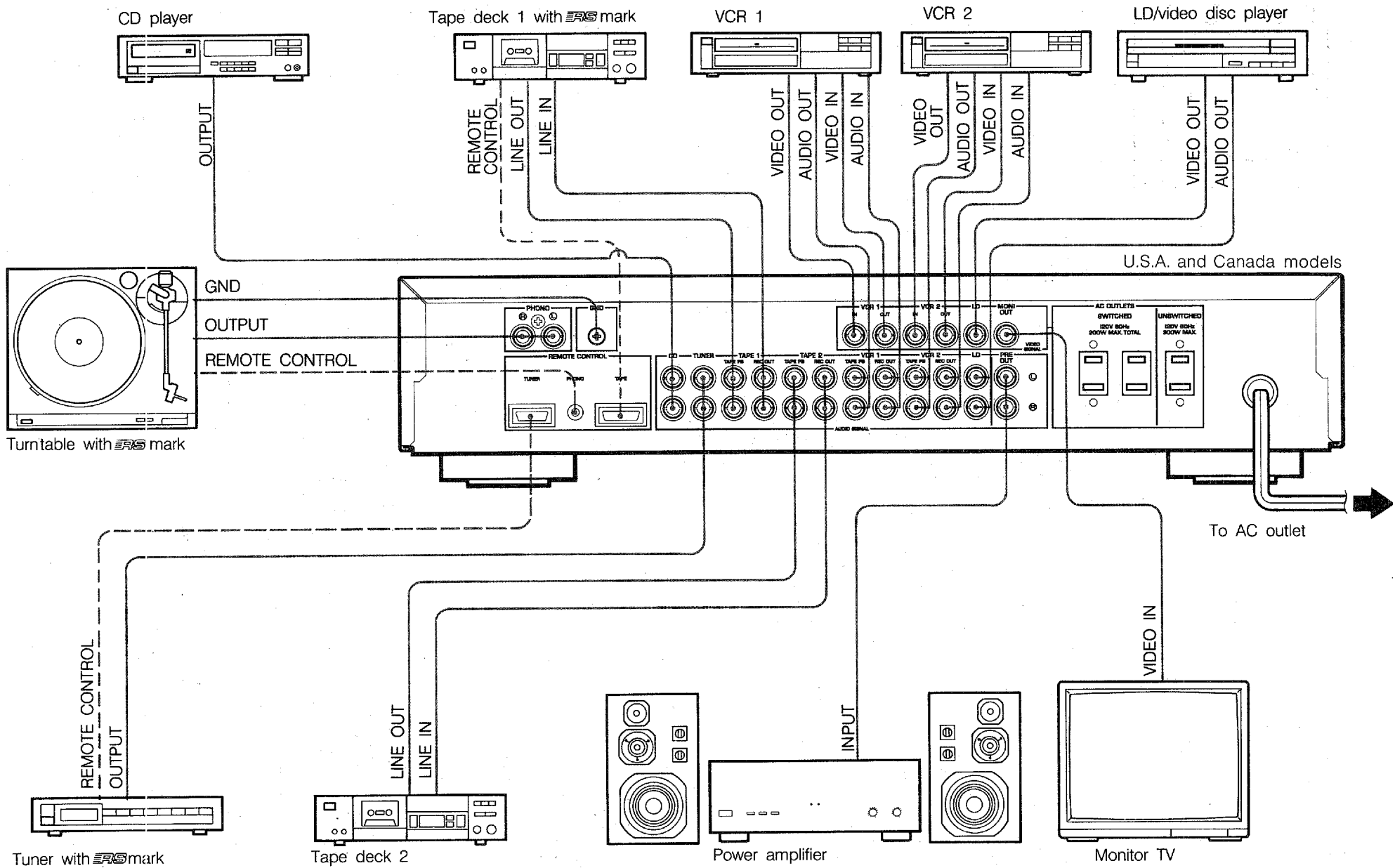

Tuner with RAS mark

Tape deck 2

Power amplifier

Monitor TV

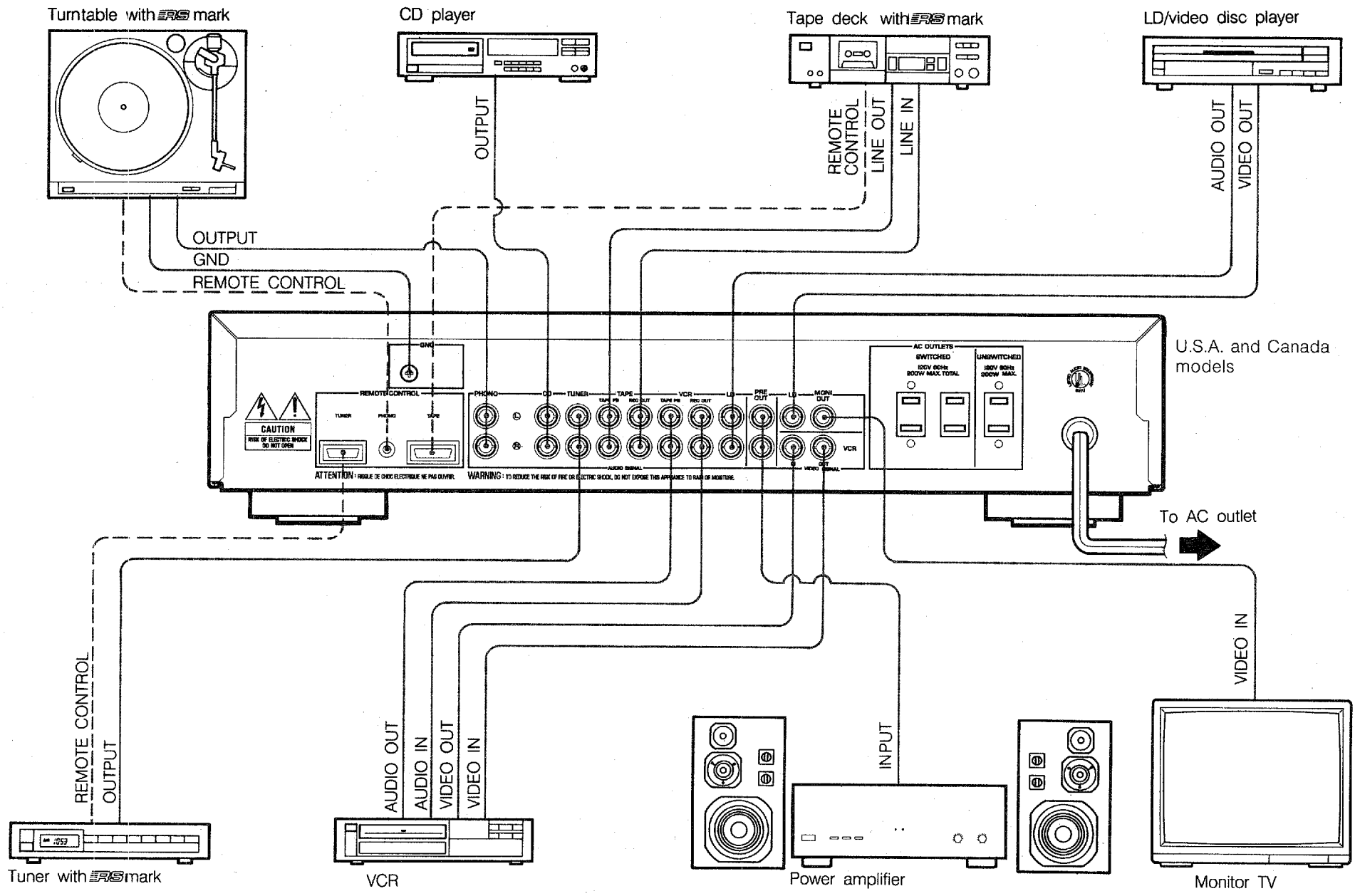

## SUPPLIED ACCESSORIES

After unpacking, check that the following parts are contained.

- Remote Control Transmitter

- Batteries

**CX-830**

(U.S.A. and Canada models)

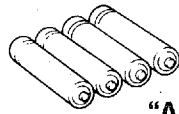
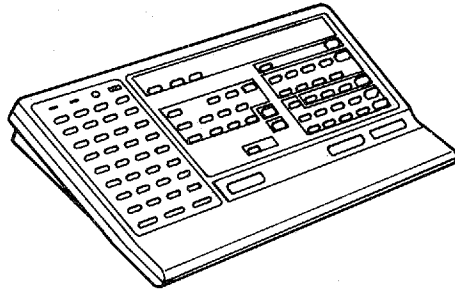

"AA" R06

(Europe, U.K., Australia and General models)

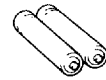
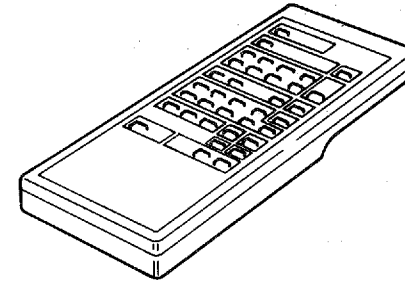

"AAA" R03

**CX-630**

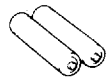
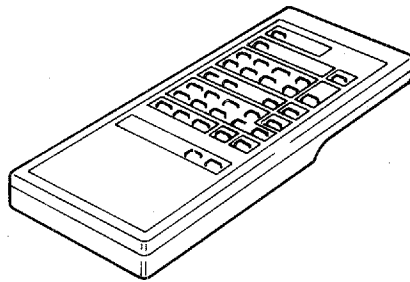

"AAA" R03

- Audio Cord

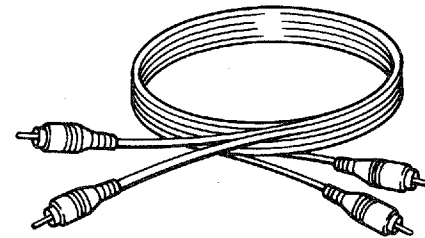

- Remote Control Cable (mini-plug, turntable)

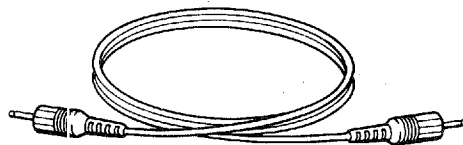

- Remote Control Cable (6-pin, tape deck)

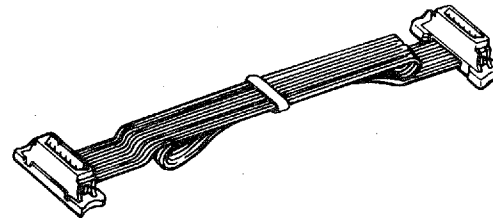

- Remote Control Cable (5-pin, tuner)

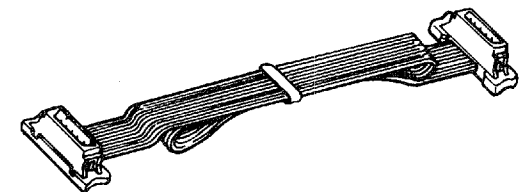

## DIFFERENCES BETWEEN CX-830 AND CX-630

This Owner's Manual covers two models, CX-830 and CX-630. Before reading this Owner's Manual therefore, the user should note that there are differences between the two models. Concerning these differences, CX-830 and CX-630 are individually given the corresponding instructions. Refer to the instruction applicable to your unit.

Because the specifications are also different, refer to "SPECIFICATIONS" on page 23.

## FRONT PANEL DESCRIPTIONS

(See Fig. 1)

### ① POWER SWITCH (POWER)

Press once to switch the power ON and once again to switch the power OFF. Before switching the power ON, set the VOLUME control to the lowest volume level (fully counterclockwise), to protect the speakers from sudden high-level sound.

### POWER-ON INDICATOR (EXCEPT EUROPE MODEL)

### POWER-ON/STANDBY INDICATOR (EUROPE MODEL ONLY)

This indicator is illuminated by switching the power ON.

While the power is ON, you can switch the unit to the standby mode by pressing the POWER key on the remote-control transmitter. In this mode the POWER-ON indicator will be half darkened; other indicators will stop illuminating. To switch the power ON again, press the POWER key on the remote-control transmitter once again. To switch the power OFF, however, the POWER switch on the main unit should be pressed.

### ② REMOTE CONTROL sensor

This can be used to receive signals from the remote-control transmitter.

### ③ INPUT indicator

The illuminated indicator indicates which program source has been selected by the INPUT SELECTOR.

### ④ INPUT SELECTOR

This selector is used to select the program source you wish to listen to or watch.

### ⑤ SOURCE DIRECT SWITCH (SOURCE DIRECT)

This switch can be used to route the audio input signals directly to the output stage, bypassing the tone controls, MODE, LOUDNESS, BALANCE controls and SUBSONIC FILTER switch except the MUTING circuit (CX-830 only) and VOLUME control. By avoiding "muddying" caused by these switches and circuit routings, pure sound can be provided.

### ⑥ Audio MUTING indicator <CX-830 only>

This indicator lights when muting is engaged (from the remote control unit). By pressing the MUTING (-20 dB) key of the remote-control transmitter, the sound level will be muted by 20 dB.



### **7 VOLUME CONTROL (VOLUME)**

This controls the sound level. Turning it clockwise increases the sound volume, and turning it counterclockwise decreases it. Set this control to the minimum level before switching ON the power or using an input selector to select a different sound source, therefore protecting the speakers from sudden high-level sound.

### **8 REC-OUT SELECTOR (REC OUT)**

This switch can be used to select a program source and supply that source directly to the rear panel REC OUT terminals, independently of the settings of the INPUT SELECTOR. This function therefore allows you to record the selected program source while listening to another program source.

### **9 PHONO SELECTOR (PHONO)**

<CX-830>

Set this selector to the position corresponding to the type of cartridge being used by the turntable: MM (moving magnet: 1 kohm, 47 kohms/330 pF or 47 kohms/220 pF) or MC (moving coil: 1 kohm, 100 ohms or 10 ohms). However, in case of using high output MC cartridges, select the MM position.

<CX-630>

This selector can be used to select either the MM (moving magnet) or MC (moving coil) position to match the phono cartridge used. However, in case of using high output MC cartridges, select the MM position.

### **10 MODE SWITCH (MODE)**

This switch can be used for switching between stereo and monaural operation. Normally this switch should be set to the stereo position.

### **11 SUBSONIC-FILTER SWITCH (SUBSONIC FILTER)**

This switch can be used to cut out ultra-low-frequency signals caused by turntable rumble or warped records, but without losing sound quality.

### **12 Continuous variable LOUDNESS control**

This control can be used to retain full tonal range at any volume levels. The sensitivity of ears to high and low frequency ranges will be lost at low volume settings. However, this control provides an equalization curve based on human hearing.

To adjust the LOUDNESS control to your listening level, first, set the control to the FLAT position, turn the VOLUME control to your loudest listening level, then turn the LOUDNESS control counterclockwise to reduce the volume level without losing the natural tone.

### **13 BALANCE CONTROL (BALANCE)**

This is used to adjust the relative volume of the left and right channels, enabling you to compensate for unbalance created mainly by the locations of the speakers.

### **14 TONE CONTROLS BASS CONTROL (BASS)**

This controls bass response. Turn it clockwise to boost (or counterclockwise to attenuate) bass response. When this control is at the center (DEFEAT) position, a flat response is obtained.

### **TURNOVER-FREQUENCY SWITCHES**

These switches can be used to adjust the turnover point of the tone controls: either 200 or 400Hz for BASS, and either 2.5kHz or 5kHz for TREBLE. This gives you flexible control over bass and treble response characteristics.

### **TREBLE CONTROL (TREBLE)**

This controls treble response. Turn it clockwise to boost (or counterclockwise to attenuate) treble response. When this control is at the center (DEFEAT) position, a flat response is obtained.

### **15 HEADPHONES JACK (PHONES)**

Stereo headphones with a standard plug can be connected to this jack. This jack is used to privately listen to the sound. Insert the headphone plug into it. The sound from the speakers will not be heard.

## CONNECTIONS

(CX-830: See Fig. 2, CX-630: See Fig. 3.)

Before making any connections switch OFF all equipment.  
Be sure to connect the left (L) and right (R) channels consistently between components.

### ● CONNECTING POWER AMPLIFIER

Connect the PRE OUT terminals of this unit to the INPUT terminals of the power amplifier.

### ● CONNECTING TAPE DECK

<CX-830>

Connect the wire from a tape deck or other audio tape unit to the TAPE 1 terminals, and connect a second tape deck, or another audio tape unit, to the TAPE 2 terminals. The playback (LINE OUT) terminals of the tape deck go to the TAPE PB terminals, and the record (LINE IN) terminals go to the REC OUT terminals on the rear panel of this unit.

<CX-630>

Connect the wire from a tape deck or other audio tape unit to the TAPE terminals. The playback (LINE OUT) terminals of the tape deck go to the TAPE PB terminals, and the record (LINE IN) terminals go to the REC OUT terminals on the rear panel of this unit.

### ● CONNECTING POWER CORD

Connect the power cord of this unit to an AC outlet.

### ● CONNECTING TURNTABLE

Connect the output wires of the turntable to the PHONO terminals and connect the ground wire to the GND terminal. Normally, connecting the ground wire produces minimum hum, but in some cases better results are obtained with the ground wire disconnected. The turntable component and its output wires should be positioned well away from sources of hum such as power cords or power transformers of other system components.

### ● CONNECTING TUNER

Connect the wires from the tuner's output terminals to the TUNER terminals of this unit. Position the tuner so that its antenna is well away from this unit for the best possible reception.

### ● CONNECTING CD (COMPACT-DISC) PLAYER

Connect the output wires from the CD player to the CD terminals. Please note that a turntable cannot be connected to these terminals (because they are not provided with the necessary RIAA equalization).

### ● REMOTE CONTROL CONNECTORS

These connectors are used when you have YAMAHA components (with the *RS* mark).

These connections allow you to control the components from the provided remote control transmitter.

#### PHONO

Connect to a turntable using the cable with miniplug connectors.

#### TUNER

Connect to a tuner using the cable with 5-pin connectors.

#### TAPE

Connect to a tape deck using the cable with 6-pin connectors.

Note that no cable is necessary for a compatible CD player, a compatible tape deck, a compatible tuner, etc. which has a remote control sensor because the remote control transmitter operates them directly.

- **CONNECTING VCR (VIDEO CASSETTE RECORDER)**

- <CX-830>

- Connect the video terminals of the VCR to the VCR 1 (VIDEO SIGNAL) terminals, and connect the video terminals of a second VCR to the VCR 2 (VIDEO SIGNAL) terminals on the rear panel of this unit. The video playback (VIDEO OUT) terminal of the VCR goes to the IN terminal, and the video record (VIDEO IN) terminal goes to the OUT terminal.

- Connect the audio output terminals of the VCR to the VCR 1 (AUDIO SIGNAL) terminals, and connect the audio output terminals of a second VCR to the VCR 2 (AUDIO SIGNAL) terminals.

- The audio playback (AUDIO LINE OUT) terminals of the VCR go to the TAPE PB terminals, and the audio record (AUDIO LINE IN) terminals go to the REC OUT terminals.

- <CX-630>

- Connect the video terminals of the VCR to the VCR (VIDEO SIGNAL) terminals. The video playback (VIDEO OUT) terminal of the VCR goes to the IN terminal, and the video record (VIDEO IN) terminal goes to the OUT terminal.

- Connect the audio output terminals of the VCR to the VCR (AUDIO SIGNAL) terminals. The audio playback (AUDIO LINE OUT) terminals of the VCR go to the TAPE PB terminals, and the audio record (AUDIO LINE IN) terminals go to the REC OUT terminals.

- **CONNECTING MONITOR TV**

- Connect the video terminal from a monitor to the MONI OUT terminal. Note that the audio connections to the monitor are not necessary as the audio portion of the signal is sent to your speakers through this unit.

- **CONNECTING LD/VIDEO DISC PLAYER**

- Connect the video output terminal from a LD player or a video disc player to the LD (VIDEO SIGNAL) terminal.

- Connect the audio output terminals from a LD player or a video disc player to the LD (AUDIO SIGNAL) terminals.

- **CONNECTING POWER CORDS OF OTHER COMPONENTS**

- <CX-830>

- General model**

- For added convenience, this unit has 3 AC outlets, two "switched" outlets (the power to these receptacles is switched ON and OFF by this unit's power switch) and one "unswitched" outlet (the power to this receptacle is independent of this unit's power switch). Be sure not to connect appliances totaling more than 200 watts to the two switched outlets or more than 400 watts to the unswitched outlet.

- U.S.A. and Canada models**

- In the same way, this unit has 3 AC outlets, two "switched" outlets and one "unswitched" outlet. The maximum power to the "switched" outlets is also 200 watts. However, note that the maximum power to the "unswitched" outlet is 300 watts.

- British, Australia, and Europe models**

- The maximum power that can be connected to the "switched" AC outlet is 100 watts.

- <CX-630>

- U.S.A., Canada and General model**

- For added convenience, this unit has 3 AC outlets, two "switched" outlets (the power to these receptacles is switched ON and OFF by this unit's power switch) and one "unswitched" outlet (the power to this receptacle is independent of this unit's power switch). Be sure not to connect appliances totaling more than 200 watts to the two switched outlets or more than 200 watts to the unswitched outlet.

- British, Australia, and Europe models**

- The maximum power that can be connected to the "switched" AC outlet is 100 watts.

## OPERATIONS

### <CX-830>

#### TO PLAY A PROGRAM SOURCE

1. Before switching this unit ON, switch on the components to be listened to or watched.
2. Turn the VOLUME control to the minimum level and then switch the power ON. The power indicator will then illuminate.
3. Select the desired program source by the INPUT SELECTOR. The corresponding input indicator will then illuminate.  
When PHONO is selected, note that the PHONO selector should be set to the position corresponding to the type of cartridge being used by the turntable.
4. Play the program source.
5. Adjust the VOLUME, LOUDNESS, tone and BALANCE controls to provide the desired sound quality.

#### TO RECORD A PROGRAM SOURCE

1. Select the program source to be recorded by using the REC OUT selector.
2. To listen to program source to be recorded, press the left or right side of the INPUT SELECTOR until the corresponding indicator is lit.
3. Play the program source to be recorded and set the tape deck or the VCR to the record mode.
4. To listen to other program source during recording, select the program source to be listened to with the INPUT SELECTOR.

When your tape deck has three head monitoring capability, select the corresponding tape source with the INPUT SELECTOR to listen to just recorded signal.

The settings of the tone controls, BALANCE, LOUDNESS and VOLUME control, etc. do not affect the recording.

#### TO DUB FROM AN AUDIO TAPE DECK

1. Set the REC OUT selector to select the program source (TAPE 1 or TAPE 2) to be dubbed.
2. To listen to the program source to be dubbed, press the left or right side of the INPUT SELECTOR until the corresponding indicator is lit.
3. Set the tape deck sending the audio signals to the play mode. At the same time, set the tape deck or the VCR receiving the signals to the record mode.
4. To listen to other program source during dubbing, select the program source to be listened to by using the INPUT SELECTOR.

When your tape deck has three head monitoring capability, select the corresponding tape source by using the INPUT SELECTOR to listen to just recorded signal.

The settings of the tone controls, BALANCE, LOUDNESS and VOLUME control, etc. do not affect the dubbing.

#### TO RECORD A VIDEO SOURCE

1. Select the desired program source to be recorded by using the REC OUT selector.
2. Set the VCR for recording to the record-pause mode.
3. Play the video source to be recorded and start recording with the recording VCR at the same time.

#### TO DUB FROM A VCR (VIDEO CASSETTE RECORDER)

1. Set the REC OUT SELECTOR to select the program source (VCR1 or VCR2) to be dubbed.
2. Set the VCR sending the audio signals to the play mode. At the same time, set the VCR or the tape deck receiving the signals to the record mode.
3. To listen to other program source during dubbing, select the program source to be listened to by using the INPUT SELECTOR.

The settings of the tone controls, BALANCE, LOUDNESS and VOLUME control, etc. do not affect the dubbing.

## <CX-630>

### **TO PLAY A PROGRAM SOURCE**

1. Before switching this unit ON, switch on the components to be listened to or watched.
2. Turn the VOLUME control to the minimum level and then switch the power ON. The power indicator will then illuminate.
3. Select the desired program source by the INPUT SELECTOR. The corresponding input indicator will then illuminate.  
When PHONO is selected, note that the PHONO selector should be set to the position corresponding to the type of cartridge being used by the turntable.
4. Play the program source.
5. Adjust the VOLUME, LOUDNESS, tone and BALANCE controls to provide the desired sound quality.

### **TO RECORD (OR DUB) A PROGRAM SOURCE**

1. Select the program source to be recorded (or dubbed) by using the REC OUT selector.
2. To listen to or watch program source to be recorded (or dubbed), press the left or right side of the INPUT SELECTOR until the corresponding indicator is lit.
3. Play the program source to be recorded (or dubbed) and set the tape deck or the VCR to the record mode.
4. To listen to or watch other program source during recording (or dubbing), select the program source to be listened to or watched with the INPUT SELECTOR.

When your tape deck has three head monitoring capability, select the corresponding tape source with the INPUT SELECTOR to listen to just recorded signal.

The settings of the tone controls, BALANCE, LOUDNESS and VOLUME control, etc. do not affect the recording.

# REMOTE-CONTROL TRANSMITTER

## CONTROLS AND THEIR FUNCTIONS

<CX-830>

(U.S.A. AND CANADA MODELS)

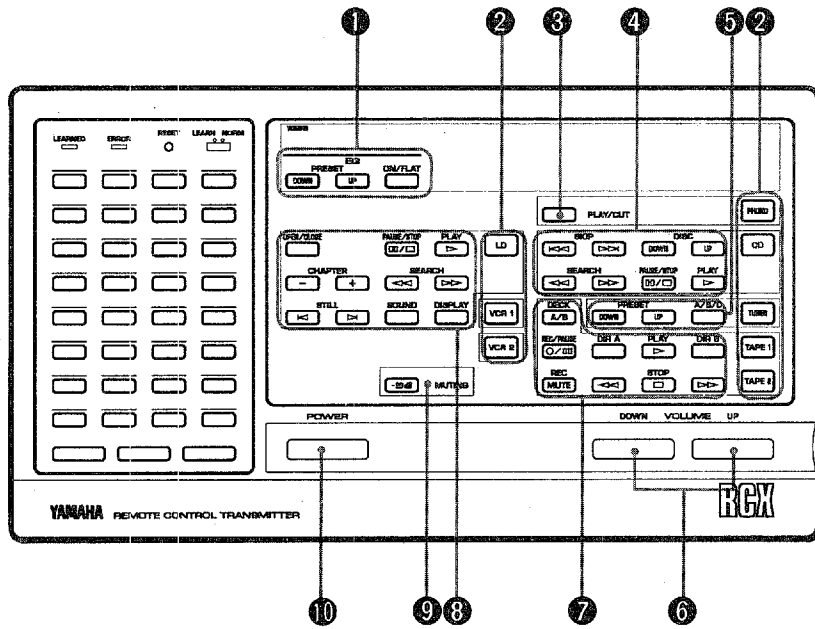

(EUROPE, U.K., AUSTRALIA  
AND GENERAL MODELS)

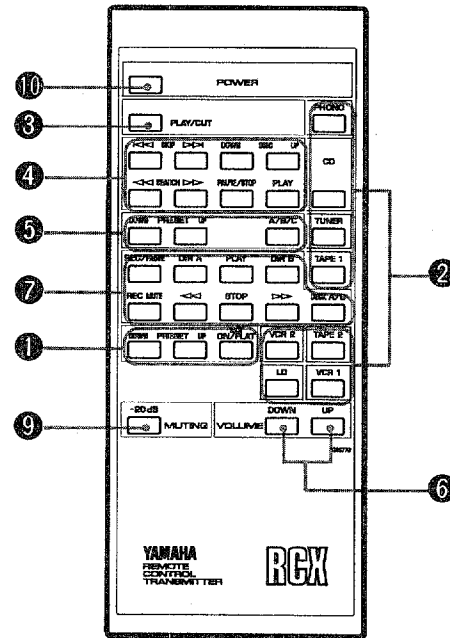

<CX-630>

(All models)

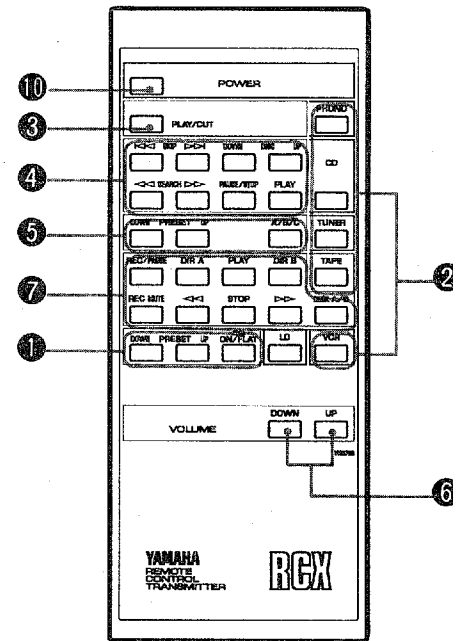

The remote-control transmitter provided with this unit is designed to control all the most commonly used functions of the amplifier. If the CD player, LD player, turntable, tuner, tape deck and graphic equalizer connected to this unit are YAMAHA components designed for remote control compatibility (components with an **RS** mark), then this remote-control transmitter will also control various functions of each component. Please consult YAMAHA dealer for information on which components are compatible with the remote-control transmitter. Note that any compatible YAMAHA CD player, graphic equalizer, tuner, LD player or a compatible YAMAHA tape deck with a remote control sensor, can be directly operated by this remote-control transmitter.

#### ① Graphic-equalizer keys

These keys can be used for operation of a YAMAHA graphic-equalizer (such as model EQ-630, etc.) if it has the presetting function.

##### **EQ ON/FLAT key**

This key can be used to select whether or not to use the circuitry of a graphic-equalizer connected to this unit.

##### **PRESET UP/DOWN keys**

These keys can be used to select any of the preset "memories".

#### ② Input selector keys

These keys are used to select the audio or the video source.

#### ③ PLAY/CUT key

This key can be used to start or stop disc play on the turntable (with the **RS** mark) connected to this unit. This key functions in the same way as the PLAY/CUT key on the turntable itself. Press it once to start play, and once again to stop play.

#### ④ CD (Compact-disc) player keys

A YAMAHA CD player with the **RS** mark can, when connected to this unit, be directly controlled by using this remote-control transmitter.

##### **SKIP $\triangleright\triangleright$ key**

Press this key to advance to the beginning of the next track on the disc.

##### **SKIP $\triangleleft\triangleleft$ key**

Press this key to return to the beginning of the track now playing.

If this key is pressed at the beginning of a track, play will begin from the beginning of the previous track.

##### **SEARCH $\triangleright\triangleright$ key**

Press this key to advance rapidly.

##### **SEARCH $\triangleleft\triangleleft$ key**

Press this key to reverse rapidly.

##### **DISC UP/DOWN keys**

These keys are used for selection of the disc, and are applicable only to CD players that have the magazine type of automatic disc-changing mechanism.

**Note:** If a carousel-type CD player is used, the DISC DOWN key has no function (only the DISC UP key operates to select the next disc in the carousel).

##### **PAUSE/STOP key**

This key is used to stop (or temporarily stop: pause) the CD player operation.

Play stops temporarily when the key is pressed once, and changes to a complete stop when the key is pressed again.

##### **PLAY key**

Press this key to play the CD.

#### ⑤ Tuner keys

A tuner with the **RS** mark can be controlled by using this remote-control transmitter.

##### **A/B/C key**

This key is used to switch between the three banks of station presets.

##### **PRESET UP and DOWN keys**

These keys are used to switch to the next higher (UP) or the lower (DOWN) preset station.

#### ⑥ VOLUME control keys

These keys are used to adjust the volume level from the speakers.

##### **<U.S.A. and Canada models of CX-830 only>**

These keys also have the "learning" function. Refer to "ABOUT THE 'LEARNING' FUNCTION" on page 18 for details.

#### ⑦ Tape deck keys

A tape deck with the **RS** mark can, when connected to this unit, be controlled by using this remote-control transmitter.

##### **DECK A/B key**

Press this key to select either deck A or deck B if the tape deck connected is a double-cassette tape deck.

### ◀◀ and ▶▶ keys

Press these keys to advance the tape rapidly in the direction of the arrow.

### PLAY key

Press this key to start tape playback. If the deck connected is a double-cassette tape deck, the tape in the deck that played back most recently will begin playback when this key is pressed.

### REC/PAUSE key

Press this key to set the tape deck to the recording-pause mode.

### STOP key

Press this key to stop the tape movement.

### REC MUTE key

Press this key to make a non-recorded space on the tape while a recording is in progress.

### DIR A key

Press this key to change the moving direction of the tape. If a double-cassette tape deck is used, this key changes the moving direction of the tape in the deck A.

### DIR B key (for use with a double-cassette tape deck only)

Press this key to change the moving direction of the tape in the deck B.

### ⑧ LD player keys <U.S.A. and Canada models of CX-830 only>

A YAMAHA LD player (such as CDV-1600 or other models) that bears the  mark can, when connected to this unit, be directly controlled by using this remote-control transmitter.

### OPEN/CLOSE key

Press this key to open or close the disc tray.

### PAUSE/STOP key

Press this key once to temporarily stop the LD player operation; when it is pressed again, the LD player changes to the stop mode.

### PLAY key

Press this key to start the disc play.

### CHAPTER keys (LD)

- + When this key is pressed during LD play, the beginning of the next "chapter" is detected.
- When this key is pressed during LD play, the beginning of the "chapter" now playing is detected.

### SEARCH keys

▶▶ When this key is pressed during play, play is advanced at high speed.

◀◀ When this key is pressed during play, play is reversed at high speed.

### STILL keys (CAV)

▶ When this key is pressed during LD (CAV) play, a still picture or frame-by-frame pictures can be displayed in the forward direction.

◀ When this key is pressed during LD (CAV) play, a still picture or frame-by-frame pictures can be displayed in the reverse direction.

### SOUND select key (LD)

This key can be used to select the sound to be played from the disc and which will be output from the left and right audio signal output jack. The selected audio signal changes in the order: STEREO → 1/L-CH → 2/R-CH each time the key is pressed.

### DISPLAY key

When this key is pressed during the play of a LD (CAV) disc, the "chapter" and frame numbers of the picture now being viewed are displayed on the screen.

When this key is pressed during the play of a LD (CLV) disc, the "chapter" number and the time are displayed on the screen.

When this key is pressed during the play of a CD, the total time, the remaining time or the track time is displayed on the screen.

### ⑨ MUTING (-20 dB) key <CX-830 only>

Press this key to mute the sound level by 20 dB. Press the key again to resume original sound level.

This key is very convenient for lowering the volume level temporarily (for instance, to answer a phone call) without disturbing the original volume level setting.

### ⑩ POWER key

Refer to "POWER-ON INDICATOR" or "POWER-ON/STANDBY INDICATOR" in ❶ of "FRONT PANEL DESCRIPTIONS".



## ■ BATTERY INSTALLATION/REPLACEMENT

- Install the batteries as shown below.

### CX-830 (U.S.A. and Canada models)

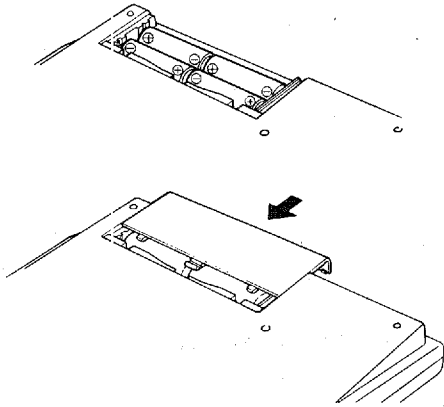

### CX-830 (Europe, U.K., Australia and General models) CX-630 (All models)

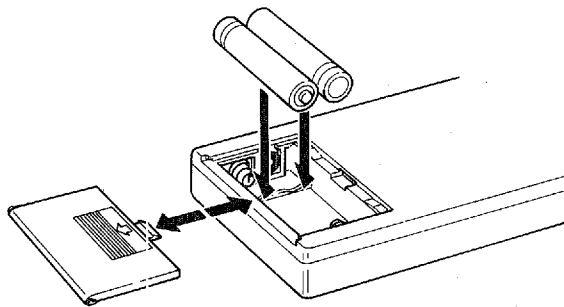

- Be sure to follow the diagram in the battery compartment to assure the proper positive (+) and negative (-) polarity.
- Do not use old and new batteries at the same time.
- If a battery leaks, dispose of all batteries; then clean the battery compartment thoroughly before installing new batteries.

## ■ OPERATION RANGE

The remote-control transmitter must be faced toward the component to be controlled, and be within a range of about 7 meters (23 feet) for proper operation.

### CX-830 (U.S.A. and Canada models)

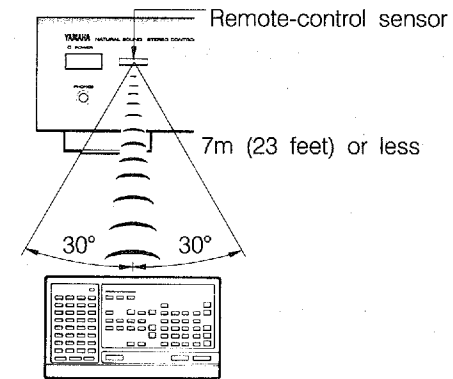

### CX-830 (Europe, U.K., Australia and General model) CX-630 (All models)

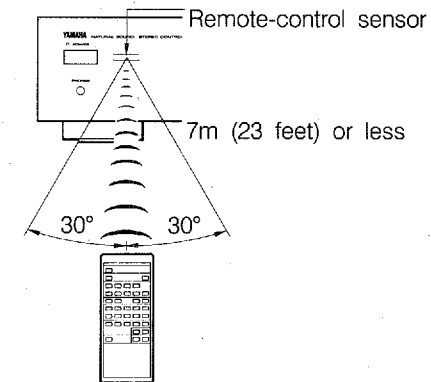

**<CX-830 ONLY>**

**■ ABOUT THE "LEARNING" FUNCTION  
(applicable to U.S.A. and Canada models only)**

This remote-control transmitter has a number of programmable keys. These keys can be programmed to "learn" the signal patterns from other remote-control transmitters.

By programming this unit with the signals from other remote-control transmitters, this unit can then be used in place of one or more other remote-control transmitters, thus making operation of your various audio and video components more convenient.

**NOTE**

There may occasionally be instances, due to the signal-coding and modulation systems employed by the other remote-control transmitter, that this unit will not be able to "learn" its signals.

**IDENTIFICATION OF PARTS**

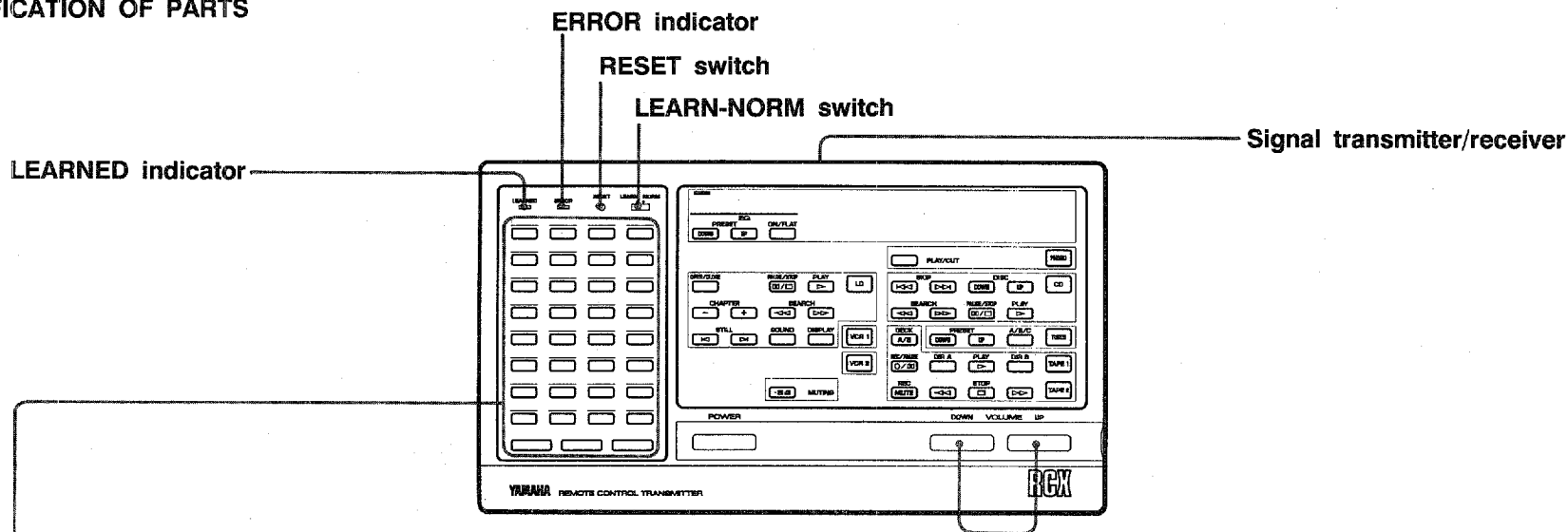

**Learning keys**

These keys can be used to "learn" (program) signals from other remote-control transmitters.

**Programmable preset learning keys**

These keys have already been preset with signals for controlling the sound volume, but, if desired, other signals can be "learned" by these keys (over the preset signals), in the same way as the ordinary learning keys.

(The "learning" method is the same as that for the ordinary learning keys.)

\* These keys are convenient for programming signals for use as the master volume control of a YAMAHA digital-sound-field processor (model DSP-3000, DSP-100, DSR-100PRO, etc.) and so on.

## TO PROGRAM SIGNALS FROM OTHER REMOTE-CONTROL TRANSMITTERS

### Before programming

- Some learning keys are larger than others, but all keys are potentially capable of the same functions if so programmed. Keys should be programmed and used according to their positional convenience.
- Use the included seals to indicate the functions for which learning keys have been programmed. It is recommended that you first determine the best and most convenient layout of the keys for the various functions you plan to program (and attach the seals accordingly), and then program the keys correspondingly.

### Follow the steps described below to program signals from other remote-control transmitters to this unit.

1. Set the LEARN-NORM switch to the "LEARN" position.

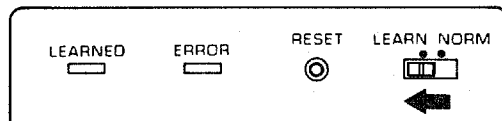

2. Position this unit and the other remote-control transmitter head to head.

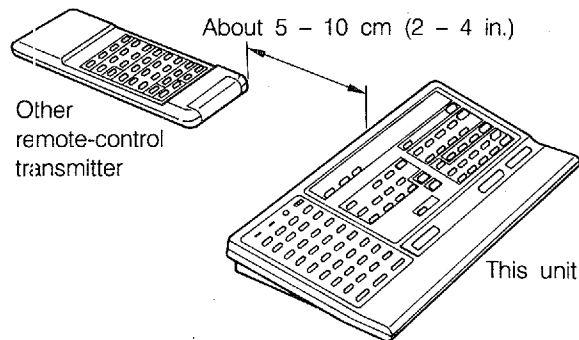

3. Press the learning key (or programmable preset learning key) on this unit to which the programming will be made.

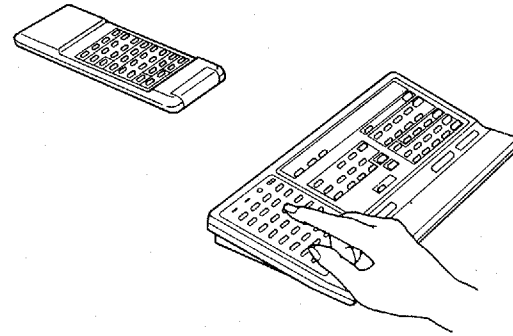

- \* If the pressed key is unprogrammed, the LEARNED indicator will flash continuously. If the key is already programmed, the LEARNED indicator will flash continuously and, at the same time, the ERROR indicator will illuminate. Then proceed to the next step if you want to change that instruction already programmed for the key. If you do not want to change it, however, press the key to be programmed next and proceed to the "learning" operation of that key.

4. Press the key (on the other remote-control transmitter) for the function to be programmed.

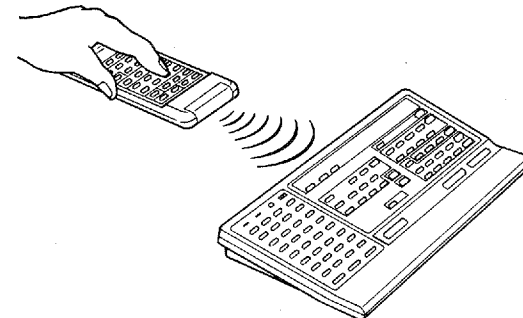

\* The LEARNED and ERROR indicators will illuminate continuously while the signals from the other remote-control transmitter are being received by this unit. Press and hold the key on the other remote-control transmitter until the illumination of these indicators stops. The LEARNED indicator will illuminate for about two seconds when the programming of signals has been successfully completed.

5. Repeat steps 3 and 4 until the signals for all programmings you want to make are successfully programmed.

6. After all programming is completed, set the LEARN-NORM switch to the "NORM" position.

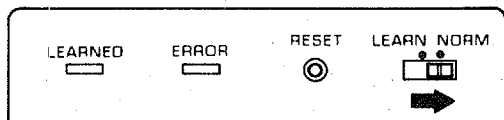

After all programming is completed, try operating this unit.

### Notes

- Note that the successful programming of signals to a learning key results in the erasure of previously programmed signals and their replacement by the newly programmed signals.
- In step 4, if the key on the other remote-control transmitter is not pressed within 15 seconds after a learning key is pressed, this unit will automatically return to the status that was in effect before the learning key was pressed.

- If the signals are not successfully programmed to this unit, the ERROR indicator will flash for about two seconds. If signals to be programmed are too long and this unit cannot program them, this unit automatically expands the work area capacity to be doubled, and will then await the next entry. During this stand-by mode the LEARNED indicator flashes rapidly. If this happens, try programming again.
- Although, because this unit employs the variable length programming method, long signals can also be programmed, if all signals programmed are long signals, it might happen that the capacity of the memory area would be completely used before all keys that are programmable are actually programmed, and no further programming would be possible. If this happens, after the signals from the other remote-control transmitter is received (in step 4), the LEARNED indicator and the ERROR indicator will flash two times.

### Memory back-up

All of the programmed functions will be retained while you replace the batteries. However, if no batteries are installed for a few hours, the memory will be erased and will have to be programmed again.

### Trouble shooting guide

- If programming cannot be made successfully, or if this remote-control transmitter does not function even though the programming was successful, check the following points:
  - \* Check whether the batteries of the other remote-control transmitter are weak.
 

Note that even though its batteries may be strong enough to operate the component it was made for, they may be too weak to transfer signals to this unit. If so, replace the batteries of the other remote-control transmitter.
  - \* Check whether the distance between the two remote-control transmitters is too long or too short.

- \* Check whether a strong light, such as direct sunlight, is striking the signal transmitter/receiver of this unit.
- The remote-control transmitter's batteries are too weak if the LEARNED indicator and the ERROR indicator do not illuminate or flash, or if the distance or range within which the remote-control transmitter can be used decreases.  
If either occurs, replace the batteries with new ones.
- If, due to a cause other than the above, the indicators do not function during the programming operation, remove the batteries from the unit (in order to reset it) for a few minutes, and then once again insert the batteries.

#### HOW TO CLEAR SIGNALS PROGRAMMED BY THE LEARNING OPERATION

By using the RESET switch, signals that you have programmed to a learning key or to a programmable preset learning key can be canceled. For a programmable preset learning key, there is a return to the originally preset commands for volume control of the control amplifier when this switch is pressed.

1. Set the LEARN-NORM switch to the "LEARN" position.

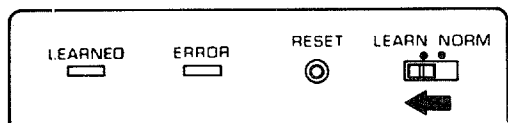

2. Press the RESET switch using the point of a mechanical pencil, etc..  
The LEARNED and ERROR indicators will illuminate for .15 seconds.

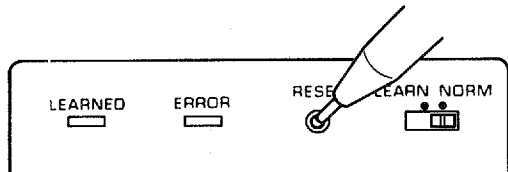

3. Press and then release the learning key (or programmable preset learning key) for which you want the programmed signal to be canceled. The LEARNED indicator's illumination and the ERROR indicator's illumination will then stop.  
Then, when the cancellation is finished, the LEARNED indicator will illuminate for one second. This indicates the completion of the cancellation process.  
To cancel two or more programmings, repeat steps 2 and 3.

#### Note

If a learning key (or a programmable preset learning key) is not pressed within 15 seconds after the RESET switch is pressed, this unit will automatically return to the status that was in effect before the RESET switch was pressed.

#### REMOTE-CONTROL OPERATION

Note the following points when using this unit for operation of audio/video equipment.

- Be sure to set the LEARN-NORM switch to the "LEARN" position.
- If this unit is faced toward the component to be operated and the key pressed correctly so that the correct signal can be transmitted, the LEARNED indicator will illuminate steadily.  
The ERROR indicator will illuminate if an unprogrammed key is pressed, or two or more keys are pressed simultaneously or one after another.
- \* If a short signal is transmitted by a learning key, this indicator's illumination will stop when signal transmission ends, even if the key is pressed for a longer time.

## TROUBLESHOOTING

Before assuming that your unit is faulty, please check the following troubleshooting list, which details corrective actions you can take yourself without calling a service engineer. If you have any questions, contact your Yamaha dealer.

PROBLEM	POSSIBLE CAUSES	REMEDY
<b>Power is not supplied even though the POWER switch is ON.</b>	The power plug is not securely connected.	Connect it securely.
<b>There is no sound when a source is selected with the INPUT SELECTOR.</b>	The wrong source is selected.	Select the desired source with the INPUT SELECTOR.
	The input wires are not connected securely.	Connect them securely.
	Power amp connections are not secure.	Plug in the connection cords, properly.
<b>There is no sound from one speaker.</b>	The BALANCE control is set all the way to the left or right.	Adjust the BALANCE control correctly.
<b>The sound from the MC cartridge is too low.</b>	PHONO selector is set to MM.	Set this switch to an MC position.
<b>There is a humming sound when playing records.</b>	The input wires are not connected securely.	Connect the input wires securely.
	The turntable's ground wire is not connected.	Connect the ground wire.
<b>Recording is not possible.</b>	The REC OUT selector is improperly set.	Set the REC OUT selector to the source you want to record.
<b>The tone controls and the LOUDNESS control does not function.</b>	The SOURCE DIRECT switch is ON.	Turn off the SOURCE DIRECT switch.
<b>The sound suddenly stops.</b>	There is a malfunction in the amplifier.	Consult your Yamaha dealer.

## SPECIFICATIONS

### Input Sensitivity/Impedance

CX-830	Phono MC	100 $\mu$ V/10 $\Omega$ , 100 $\Omega$ , 1 k $\Omega$
	MM	2.5 mV/1 k $\Omega$ , 47 k $\Omega$ (220p, 330p)
	CD/TUNER/TAPE1/TAPE2/VCR1/VCR2/LD	150 mV/47 k $\Omega$
CX-630	Phono MC	100 $\mu$ V 100 $\Omega$
	MM	2.5 mV/47 k $\Omega$
	CD/TUNER/TAPE/VCR/LD	150 mV/47 k $\Omega$

### Input Sensitivity (New IHF)

CX-830	Phono MC	33 $\mu$ V
	MM	0.83 mV
	CD/TUNER/TAPE1/TAPE2/VCR1/VCR2/LD	50 mV
CX-630	Phono MC	33 $\mu$ V
	MM	0.83 mV
	CD/TUNER/TAPE/VCR/LD	50 mV

### Maximum Input Signal

CX-830	1 kHz, 0.01% THD, Phono MC	7 mV
	1 kHz, 0.01% THD, Phono MM	180 mV
CX-630	1 kHz, 0.03% THD, Phono MC	7 mV
	1 kHz, 0.01% THD, Phono MM	170 mV

### Output Level/Impedance

	REC OUT	150 mV/2.5k $\Omega$
	PRE OUT	1.5V/47 $\Omega$

### Maximum Voltage Output

CX-830	20 Hz - 20 kHz 1% THD	12V
CX-630	20 Hz - 20 kHz 0.1% THD	8.5V or more

### Headphone Jack Rated Output/Impedance

CX-830	Output Level (0.005% THD RL=100 $\Omega$ )	4.5V
	Impedance	68 $\Omega$
CX-630	Output Level (0.1% THD RL=150 $\Omega$ )	4.4V
	Impedance	82 $\Omega$

### Frequency Response

CX-830	CD/TUNER/TAPE1/TAPE2/VCR1/VCR2/LD	20 Hz - 20 kHz (+0, -0.2 dB)
CX-630	CD/TUNER/TAPE/VCR/LD	20 Hz - 20 kHz ( $\pm$ 0.2 dB)

### RIAA Equalization Deviation

CX-830	Phono MC/MM	20 Hz - 20 kHz ( $\pm$ 0.2/ $\pm$ 0.2 dB)
CX-630	Phono MC/MM	20 Hz - 20 kHz ( $\pm$ 0.3/ $\pm$ 0.2 dB)

### Total Harmonic Distortion

CX-830	20 Hz - 20 kHz	
	Phono MC to REC OUT, 1.5V	0.002%
	MM to REC OUT, 1.5V	0.001%
	CD/TUNER/TAPE1/TAPE2/VCR1/VCR2/LD to Pre Out, 1.5V	0.001%
CX-630	20 Hz - 20 kHz	
	Phono MC to REC OUT, 3V	0.002%
	MM to REC OUT, 3V	0.002%
	(SOURCE DIRECT ON)	
	CD/TUNER/TAPE/VCR/LD to Pre Out, 3V	0.002%

### Signal-to-Noise Ratio (IHF-A Network)

CX-830	Phono MC (500 $\mu$ V Input Shorted)	90 dB
	MM (5 mV Input Shorted)	95 dB
	CD/TUNER/TAPE1/TAPE2/VCR1/VCR2/LD (Shorted)	106 dB
CX-630	Phono MC (500 $\mu$ V Input Shorted)	84 dB
	MM (5 mV Input Shorted)	94 dB
	SOURCE DIRECT (Shorted)	106 dB

### Residual Noise (IHF-A Network)

CX-830	6 $\mu$ V
CX-630	8 $\mu$ V

### Channel Separation

CX-830	(Vol -30 dB)	
	Phono MC, MM Input shorted	
	1 kHz/10 kHz	80 dB/70 dB
	CD/TUNER/TAPE1/TAPE2/VCR1/VCR2/LD Input 5.1 k $\Omega$ Terminated	
	1 kHz/10 kHz	75 dB/60 dB
CX-630	(Vol Max.)	
	Phono MC, MM Input shorted	
	1 kHz/10 kHz	80 dB/70 dB
	CD/TUNER/TAPE/VCR/LD Input 5.1 k $\Omega$ Terminated	
	1 kHz/10 kHz	70 dB/60 dB

### Tone Control Characteristics

Bass	
Boost / Cut	±10 dB (20 Hz)
Turnover frequency	200 Hz · 400 Hz
Treble	
Boost / Cut	±10 dB (20 kHz)
Turnover frequency	2.5 kHz · 5 kHz

### Video Input Sensitivity/Impedance

CX-830 VCR1, VCR2, LD	1 Vp-p/75 Ω
CX-630 VCR, LD	1 Vp-p/75 Ω

### Video Output Level/Impedance

VCR OUT, MONITOR OUT	1 Vp-p/75 Ω
----------------------	-------------

### Filter Characteristics

Subsonic	15 Hz, -12 dB/oct
----------	-------------------

### Continuous Loudness Control (Level Related Equalization)

Attenuation	-40dB (1 kHz)
-------------	---------------

Audio Muting (CX-830 only)	-20 dB
----------------------------	--------

### Gain Tracking Error

(0 - -60 dB)	2 dB
--------------	------

### Power Supply

U.S.A. and Canadian model	AC 120V/60 Hz
British and Australian models	AC 240V/50 Hz
European model	AC 220V/50 Hz
General model	AC 110/120/220/240V 60/50 Hz

### Power Consumption ..... 30

### AC Outlets

CX-830 U.S.A and Canada models	
Switched (2)	200W m
Unswitched (1)	300W m
General model	
Switched (2)	200W m
Unswitched (1)	400W m
British, Australia, and Europe models	
Switched (1)	100 W m
CX-630 U.S.A, Canada and General models	
Switched (2)	200W m
Unswitched (1)	200W m
British, Australia, and Europe models	
Switched (1)	100 W m

### Dimensions (W x H x D) ..... 435 x 96 x 301 mm (17-1/8" x 3-3/4" x 11-7/8")

### Weight

CX-830	5.4 kg (11 lbs. 14 oz)
CX-630	4.8 kg (10 lbs. 9 oz)

\* Specifications are subject to change without notice.